

A Tool for Telediagnosis of Cardiovascular Diseases in a Collaborative and Adaptive Approach

Maria-Aydee Sanchez-Santana

(Institut Femto-ST/DISC - UMR CNRS 6174
Université de Franche-Comté, Besançon, France
aydee.santana@femto-st.fr)

Jean-Baptiste Aupet

(CHRU Besançon, Besançon, France
jbaupet@chu-besancon.fr)

Marie-Laure Betbeder, Jean-Christophe Lapayre

(Institut Femto-ST/DISC - UMR CNRS 6174
Université de Franche-Comté, Besançon, France
{marie-laure.betbeder, jc.lapayre}@femto-st.fr)

Antonio Camarena-Ibarrola

(Universidad Michoacana de San Nicolás de Hidalgo, Morelia, Mexico
camarena@umich.mx)

Abstract: In this paper, we present a new telediagnosis environment for the detection of cardiovascular problems. This tool, called *VACODIS* (**VA**scular **CO**llaborative **teleDI**agnosi**S**), allows practitioners to semi-automatically identify and quantify a patient's potential cardiovascular complications. The system generates first-time automatic detection of cardiovascular abnormalities using Doppler ultrasound images. The system then provides remote collaborative sharing of this information among different doctors to allow distance telediagnosics. With this new system, different actors in the field of medicine (nurses, practitioners, etc.) will be able to contribute to a more reliable diagnosis in the cardiovascular domain.

Key Words: Collaborative work, telediagnosis, adaptability, cardiovascular complications.

Category: C.2.4, J.3

1 Introduction

This investigation is the result of the combined efforts of UMSNH University (Morelia, Mexico) and the University of Franche-Comté (Besançon, France). The team from Morelia is specialized in algorithms for image processing and segmentation, particularly in ultrasonography images (echo-Doppler). The team from Franche-Comté is specialized in distributed algorithms for collaborative telediagnosis. The objective of this work is to provide the medical community with a distributed tool for semi-automatic diagnosis in order to identify and

quantify potential cardiovascular complications in a patient. This diagnosis is composed of two steps. Firstly, cardiovascular anomalies are automatically detected from echo-Doppler images. Secondly, these images and results are adaptively and collaboratively shared to help practitioners during the collaborative diagnosis. Thus, multiple practitioners may use this tool to collaborate in a more reliable diagnosis, independently of their locations.

The second section of this article presents the medical aspect and pathology of the cardiovascular diseases. Then, in the third section, we present algorithms of automatic image processing which can detect three kinds of anomalies: atherosclerosis, endothelial dysfunction, and atherosclerosis plaque. In the fourth section we introduce a collaborative environment for telemedicine state of the art. Then, in the fifth section, we introduce a platform for automatic adaptation: WAVA. This platform ensures the sharing of information (ultrasonography images) and results of automatic detection of cardiovascular anomalies, adapting shared data in function of the available hardware capacity of each user. Finally, we end with a summary and some perspectives.

2 Medical Context

Cardiovascular disease (CVD) is still the leading cause of death worldwide. Although cardiovascular mortality rates have declined in many high-income countries over the last two decades, they have increased at an astonishingly fast rate in low- and middle-income countries. By the time heart problems are detected, the underlying cause, **atherosclerosis**, has progressed for decades and is usually quite advanced. In the CVD domain, practitioners use echography to obtain what is usually a reliable diagnosis. Echography provides images in real-time through an inexpensive and non-intrusive approach.

On the other hand, the processing of echographic images remains one of the most complex challenges in the area of image processing. Artery images present a broad dynamic range: useful details in the clinical zone may be found in a dark area as well as in the bright area of the image. Possible pathologies may be difficult to detect and remain unknown[Bishop 2000, Theodoridis et al. 2005].

2.1 Current Medical Problems

A report by the World Health Organization (WHO)¹, published in September 2011, claims CVD and control states are already the principal causes of death and disability in the world. Although a large proportion of CDVs are avoidable, they continue to rise mainly because preventive measures are inadequate. The percentage of premature deaths from CVD range from 4% to 42% in high-

¹ http://www.who.int/cardiovascular_diseases/en/

and low-income countries respectively. More than 17.3 million people died from CVDs in 2008, representing 30% of all global deaths. Over 80% of CVD deaths take place in low- and middle-income countries. The socio-economic impact is considerable: it has been predicted that approximately 23.6 million people will die from CVDs in 2030.

2.2 Pathology

Atherosclerosis is a condition in which the artery walls thicken as a result of the accumulation of fat residuals. It is a syndrome affecting arterial blood vessels, a chronic inflammatory response in the artery wall [Brusseau et al. 2004, Campbell et al.1997], caused by the formation of multiple plaques within the arteries.

Atherosclerosis typically begins in early adolescence and is found in major arteries, yet is asymptomatic and remains undetected by most diagnostic methods during most of the subjects lifetime [Fig. 1]. In addition, endothelial dysfunction is a systemic pathological state of the endothelium (the inner lining of blood vessels) and can be broadly defined as an imbalance between vasodilating and vasoconstricting substances produced by (or acting on) the endothelium [Campbell et al.1997].

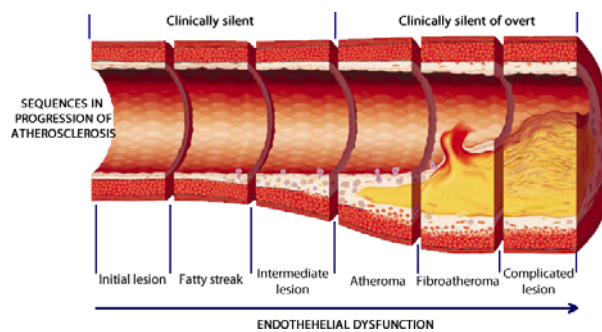

Figure 1: The evolution of atherosclerosis

Endothelial dysfunction may result from and/or contribute to several disease processes. Endothelial function testing may have great potential prognostic value for the detection of CVD, but currently the available tests are too difficult, expensive, and/or variable for routine clinical use [Rubin et al. 2000].

2.3 The Progression of Atherosclerosis

The existing methods for assessing endothelial dysfunction and atherosclerosis in humans are based on functional tests in the brachial [Fig. 2(a)] and carotid artery [Fig. 2(b)]. The role of the endothelium [Fig. 2(c)] in human disease has recently become the focus of intense scientific investigation [Davignon et al. 2004]. Impaired endothelial function is associated with a number of disease states, including CVD and its major risk factors. Endothelial dysfunction precedes overt vascular disease by years and may itself be a potentially modifiable CVD risk factor.

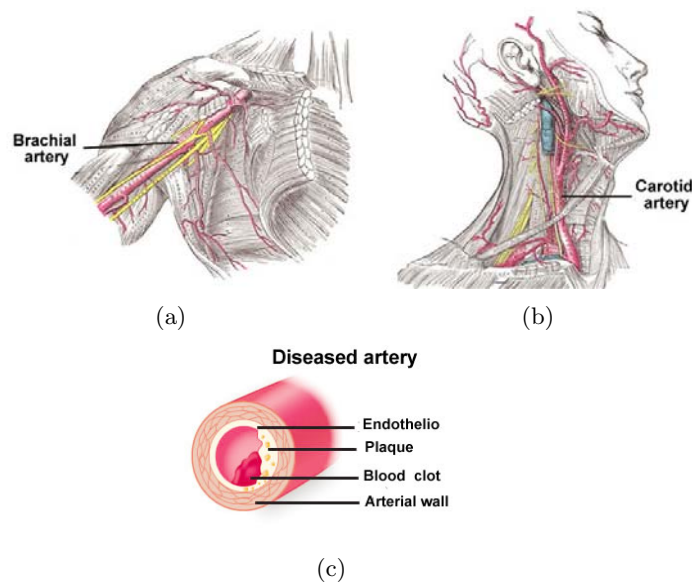

Figure 2: (a) Brachial artery, (b) Carotid artery, and (c) Diseased artery

There exists a noninvasive method for testing endothelial function, to find out whether abnormalities are present in symptom-free children and young adults at high risk of atherosclerosis. With high-resolution ultrasound, the diameter of the superficial brachial arteries is measured, while at rest, during reactive hyperaemia (with increased flow causing endothelium-dependent dilatation of 10%), and then assessed with Doppler ultrasonography [Fig. 3]: a well-tolerated, noninvasive and low-risk procedure. It is currently the most widely investigated method and shows the greatest promise for clinical application.

Carotid intima-media thickness (IMT) is considered a marker of early athero-

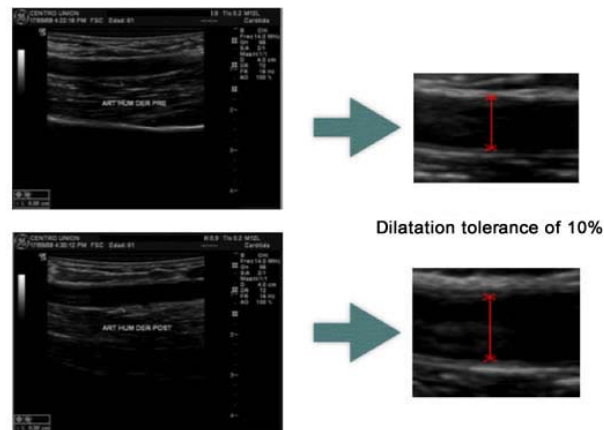

Figure 3: Flow causing endothelium-dependent dilatation

sclerosis and it has been demonstrated that it can predict future risk of cardiovascular disease in coronary patients [Severo et al. 2012]. Physicians use IMT testing to determine the age of the carotid arteries. Though patients may not be experiencing the symptoms of atherosclerosis, subtle changes in artery thickness may nevertheless be evidence of carotid atherosclerosis (carotid intima-media thickness > 0.8 mm) [Fig. 4]. The rate of change of progressive carotid atherosclerosis (determined by measurement of IMT, the distal common carotid arterial far wall) may exhibit evidence of coronary events. The structural and functional status of the vasculature are independent predictors of coronary events, as shown by noninvasive measurement of the endothelial function and carotid atheroma burden in patients. There is a risk of stratification in CVD development. Endothelial dysfunction is both an early marker of vascular disease and a facilitative process in the development of atherosclerosis. Some evidence indicates that the presence and degree of endothelial dysfunction are of prognostic importance. But these early results are tempered by the paucity of studies using noninvasive methods.

Plaque was defined as any focal protrusion above the intima. Plaque thickness was defined as the sum of the maximal thickness of all plaques [Fig. 5].

3 Methodology

Computerized methods are implemented with the intention to obtain results quickly and accurately. Calculating cardiovascular risk and detecting atherosclerosis, atheromatous plaques, and endothelial dysfunction. Digital image processing algorithms based on rules of prediction for pattern generation and acquisition

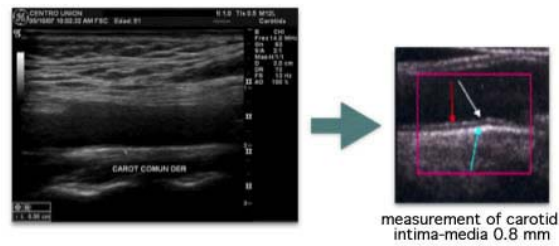

Figure 4: Carotid intima-media thickness

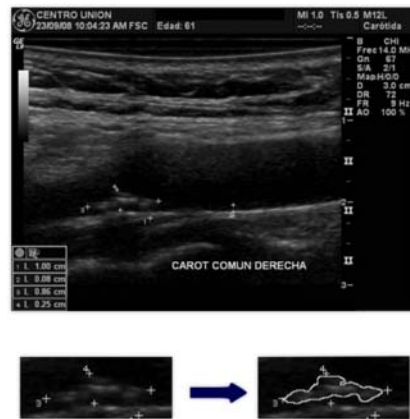

Figure 5: Atherosclerosis plaque

systems, thereby complement detection methods using arterial images and pattern extraction to determine diameters and thicknesses of vascular layers. These algorithms indicate the presence and severity of vascular disorders, with the precision needed to favor clinical monitoring of patients.

3.1 Use of Ultrasonography Image with DICOM Format

Ultrasound is the most widely used technique for in vivo measurement of Intima-Media Thickness (IMT) of the carotid and brachial artery [Pianykh 2011] and has many advantages over other radiological or imaging methods: measurements of wall arteries, wall thickness, diameters and areas. In addition, ultrasound scanners are portable and available in hospitals and clinics. Research with ultrasonography is widespread because it covers a very large percentage of the population. Perhaps the major drawback of ultrasound is that it is highly operator-dependent [Theodoridis et al. 2005], meaning that a number of technical and

methodological requirements must be met in order to perform a correct and effective computer-based endothelium measurement. To fully exploit the potential of ultrasound imaging in atherosclerosis research, image acquisition and analyses should meet DICOM standards [Loizou et al. 2005, Pham et al. 2007]. The DICOM norm integrates additional medical data within the image itself. It makes it possible to measure both image acquisition and conformity with protocols.

3.2 Segmentation: Automatic Recognition of Artery

The automatic segmentation of anatomical structures in ultrasound imagery is a real challenge due to the acoustic interference (*speckle*) noise and artifacts which are inherent in these images. *Speckle* noise depends on the distribution of points within the tissue and appears to provide visual differentiation in terms of tissue texture. For our study of CVDs, *speckle* noise has not been a problem in automated recognition. The first issue in automatic image analysis is the segmentation of the area of interest. The artery must then be recognized in the image frame. Once recognized, the distal wall of the carotid and brachial artery can be segmented in order to extract the characteristic pattern of the artery.

The basic idea consists of assuming the artery as the dark region (lumen: space where blood circulates), comprised of two bright stripes (the near and far wall artery layers). Therefore, the artery is recognized when the boundaries of the near and far wall endothelium have been traced. This procedure combines feature extraction, fitting, and the classification approach. The image is processed by column to locate the maximum intensity of each generated column by a linear discriminant to detect the artery wall [Fig. 6]. These points are called *seed points* and they are then used to link all the sequences of segmentation lines. An intelligent procedure removes false positives inside the segmentation lines and joins the nearest aligned segments. This step avoids over-segmentation, reducing *speckle* noise using a Gaussian filter applied with a sliding kernel.

This technique is user independent. Its integrated approach exploits the morphologic characteristics of the arterial wall thus enabling segmentation (recognition) in more than 95% of cases.

3.3 Automatic Detection of Vascular Anomalies

Segmentation of IMT and lumen in arteries is perhaps the most challenging problem in our investigation. Three concentric layers constitute the arterial wall and are named, from inside out: tunica intima, tunica media and adventitia [Fig. 7]. Only the tunica intima and the tunica media are controlled.

Automatic detection of CVDs and features measuring of arteries should be reliable, this implies accuracy, repeatability, robustness to noise, applicability to diverse pathologies, independence from the human operator, independence

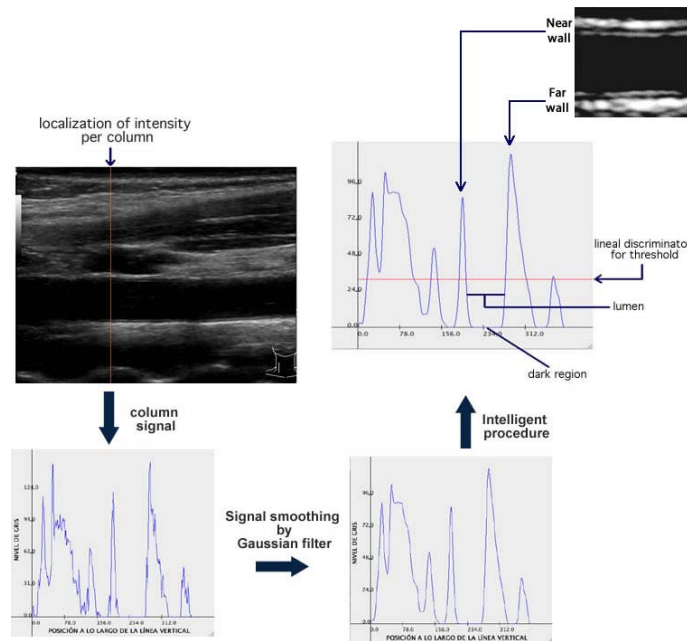

Figure 6: Artery recognition

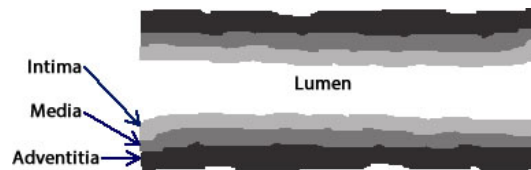

Figure 7: Representation of the transverse appearance of an artery

from the ultrasound scanner, and measurement uncertainty characterization. For our study, we propose three new tools for assisting physicians in the detection of vascular anomalies. These three methods will provide the hospital GP (or generalist in private practice) with three images and an automatic diagnosis report.

3.3.1 Measure of Lumen in Brachial Artery

Measurements of light diameter in the brachial artery must be taken between the two artery walls in the intima-lumen [Fig.7]. In most cases the two leading edges defining the lumen diameter of the brachial artery can be easily recorded. The arterial lumen must be detected via the process of detecting the edges. It is there-

fore of high importance to accurately detect the borders of the artery. We use a cellular automaton introduced by Ullman and von Neumann [Hunter et al. 1979]. A cellular automaton is basically a computer algorithm that is discrete in space and time and operates on a lattice of sites (in our case, pixels of an image). This type of technique changes its state depending on the state of the neighborhood cells at a given time, and its own previous state. A set of triplet (i, j, k) (cells) characterizes each pixel, where (i, j) represents the position of the cell associated to k -level intensity. The ultrasound can be considered a specific cellular automaton where cellular space is a window $N \times N$ within the ultrasonographic image. In our process, we consider two kinds of cells: live cells (light) and dead cells (muscle) [Fig. 8(a)].



Figure 8: (a) Edge detection using cellular automata, (b) Measurement of lumen in brachial artery

Measurement of the brachial artery lumen is determined for the internal area, a process known as region growing [Adams 1994]. It is also classified as a pixel-based image segmentation method since it involves the selection of initial seed points. This approach to segmentation examines neighboring pixels of initial seed points and determines whether the neighboring pixels should be added to the region. The process is iterated, in the same manner as general data clustering algorithms [Fig.8(b)].

3.3.2 Measure of Endothelium in the Carotid Artery

The most important determinant in the diagnosis of atherosclerosis is the measurement of the carotid IMT that is defined on a side of the artery wall. The near-wall intima/lumen is defined by the leading edge. We use the ARC-Potential method [Rivera et al. 2002] which quickly determines the IMT and preserves the edge. The IMT measure uses the edge and a collection of seed points determined with the gradient. The adventitia generally bright indicates precisely the end of IMT. Consequently, IMT measure eases to distinguish edges inside the area of common carotid of artery wall. This measure is done using the transition between the light and the artery wall (Lumen-Intima or LI) and also the transition

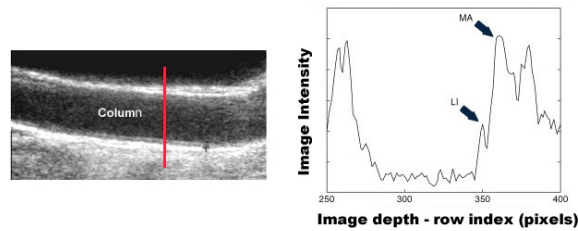

Figure 9: Carotid artery wall segmentation based on an intensity criterion and a gradient approach

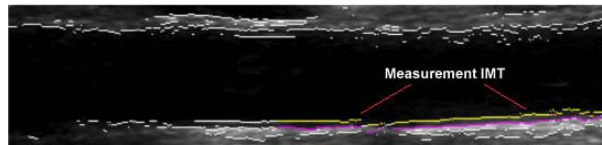

Figure 10: Measure of IMT carotid by segmentation

between the media and the adventitia (MA) [Fig. 9]. The gradient satisfies the problem of LI/MA detection. Generally, an image gradient is determined to find LI/MA points for every image columns [Fig. 10].

3.3.3 Atherosclerosis Plaque

An atherosclerosis plaque in the ultrasound image may be defined as a focal thickening of the intima-media complex that is 50% thicker than that of the adjacent region, or as a focal thickening over 1.5 mm. For automatic edge detection, we used quad-trees by combining a nonparametric classifier [Hunter et al. 1979] based on a clustering algorithm, with a quad-tree representation of the image. The scheme performs well and is simple to implement, giving satisfactory results in spite of *speckle* noise interference [Fig. 11].

Carotid bulb IMT may be measured in the majority of cases with a low dropout rate. Areas with plaque should not be excluded during measurement.



Figure 11: Plaque segmentation using the quad-tree technique

*Medición Automática de Alteraciones Carotídeas y
la Función Endotelial en la Arteria Humeral*

Paciente :	ENSAYO DE PRUEBA DE FUNCION END
Medición Intima-Media Carotídea :	0.04878048780487812 cm.
Medición Luz Humeral Pre-Estimulación :	0.3491582005232157 cm.
Medición Luz Humeral Post-Estimulación :	2.24031007751938 cm.
Medición Placa de Ateroma :	Vacio

PADECIMIENTOS

ATEROSCLEROSIS :	SI, Existe daño endotelial
DISFUNCIÓN ENDOTELIAL :	NO, Respuesta satisfactoria
OBSTRUCCIÓN DE ARTERIA :	Vacio

Figure 12: Automatic diagnosis

Based on the ultrasonographic image process, the system has determined the Intima-Media thickness, the inner area of the artery, its diameter and the endothelium. Now the system determines the cardiovascular disease risk factor and a diagnosis based on a set of rules. For example, an adult having an IMT greater than 1 millimeter has atherosclerosis. All this information is written in a text file. This text file with the original images of a patient have to be available to physicians in order to collaborate in the final diagnosis [Fig. 12]. The files have to be adapted to the different devices, networks and protocols.

In the following section, it is important to know how to adapt the diagnostic information (three images and a text) in function of devices, networks and protocols. The goal is to enable practitioners to work together and elaborate a final diagnosis in the best conditions.

In the next sections, we define (1) the real-time collaborative environment for telemedicine, and (2) our new adaptive platform Wava.

4 Collaborative Environments for Telemedicine

The CNOM (French National Council of Health Practitioners) defines Telemedicine as the practice that allows a patient to receive medical attention remotely from one or more practitioners through the use of information and communication technologies in order to deliver the required medical data.

4.1 Adaptation in Collaborative Environments

Collaborative environments consist solely of data exchange. Adaptation of data streams can be implemented to ensure that the data are adequate for user needs.

In recent years, several studies have been undertaken in the area of adaptability and especially in the adaptation of multimedia flows [Garcia et al. 2004, Dalmau et al. 2009]. Our study identifies research that ensures adaptation in distributed systems and especially in collaborative software. To understand the problems of adaptation data in these environments, it is necessary to study how these environments are used today and what constraints they face.

The ultimate goal of an adaptable collaborative system is to be able to adapt to new needs, considering the needs used in the initial analysis and evolution of the tools and technologies used [Elmarzouqi et al. 2008, Mrak et al. 2009]. These systems have come about through the joint development of both designers and users.

A choice must always be made between the needs, skills and preferences, and technological constraints, but also using the budgetary skills and habits of designers as shown by the team Nallini Selvaraj, University of New York [Selvaraj et al. 2007]. At present, the adaptation is implemented through wider applications to adapt to new ways of using computer tools, such as mobility and access to data via various devices. Websites have adapted to needs and allow us to benefit from any information in just seconds. Whether this information is in the form of text, audio or video, new communication infrastructures and terminals can display it without using additional software or codecs, provided that these data are appropriate.

The term co-evolution, suggested by Jurgen Ziegler [Ziegler et al. 2010], was chosen to reflect the fact that collaborative systems should be in continuous evolution, without, however, being independent or self-adaptive, because they are explicitly accountable for the changing needs, attitudes and skills of users, individually or collectively. Users must also change and adapt their practices and working methods to meet the changing needs of the organization. Following the development of specific applications and collaborative systems, a more industrial set up is needed in the form of platforms that integrate services and components designed for group work. New applications can be quickly developed using the building blocks that have been developed in several other studies [Duque et al. 2009] [Ziegler et al. 2010].

But, being able to adapt the data flow within the environment does not guarantee that the contents actually fit properly or even optimally. Adaptability can implement techniques when the user is not satisfied with the result. The system can be configured to adapt so as to improve the result, but the user must still know how to use these techniques and, especially, how to use them appropriately. Implementing a policy of transparent adaptability allows the user to completely forget the configuration and adaptation of the working environment. However, for this system to make the self-adaptation of context and data totally transparent, the system must take into account all relevant parameters and applications

necessary for the operation. Different methods may be used as required:

- Adaptation: the system adapts data according to criteria or predefined scenarios.
- Adaptability: the user is master of his system and makes decisions from the choices offered to him at the risk of rendering the system unstable.
- Adaptivity: The system selects the best options based on criteria selected by the user, proposing only modes compatible with the type of application, synchronous, asynchronous and system constraints (the need for bandwidth, computing capacity).

Collaborative software for telemedicine furnishes practitioners with the collaborative tools necessary to perform online diagnostics [Fuin et al. 2008]. These tools allow them to exchange information such as medical images and previous diagnoses. More and more tools are available to enable real-time diagnostics including neurology. A camera (webcam or IP camera) is used to transmit video streams directly to the patient's computer specialist who no longer needs to travel. Thus, one hospital, which does not have a specialist on site, can, by means of these tools, call upon one or more practitioners for diagnosis in the shortest possible time, which in some cases may save the patient's life. To be sure the diagnosis takes place in good conditions we must implement flow control device videos. In recent years, the rapid advances in telecommunications and the development of more efficient terminals have allowed the practice of telemedicine to grow rapidly.

4.2 The New Challenges of Collaborative Environments: Mobility/Ubiqity

Collaborative environments are also called groupware and are used to assist the work of a group of people. These environments emerged in the early 90s. They have undergone many changes since their creation, through different approaches in the design and architecture that have supported collaborative learning in all its aspects.

Over the last twenty years, the concept of remote working (teleworking) has undergone great development, largely due to the combined growth of networks and the evolution of more efficient terminals, but also due to the improved security in these systems. Collaborative environments are used in various ways such as e-Learning, [Watkins 2010], remote maintenance [Sun et al. 2002], collaborative design [Duque et al. 2009] and telemedicine [Elmarzouqi et al. 2007].

Mobile computing can now be seen as a more holistic approach than ubiquitous computing. Also known as pervasive computing [Louberry et al. 2009],

ubiquitous computing aims to render a multitude of services accessible from anywhere, while hiding the computer aspect. This desire to free the user from the constraints of the current use of a computer (sitting in front of a screen and using a keyboard) gives him his freedom of action and above all, freedom of movement. Ubiquity is built into an environment that integrates mobility. These new uses imply that new constraints must be taken into account, in addition to the constraints of working together.

Collaborative environments provide users with tools to be used in the field for which they were created, in addition to the traditional tools of chat, whiteboard and videoconferencing [Duque et al. 2009]. For medicine, the tools are specific and allow doctors to have discussions about the purpose of treating the cases diagnosed. Tools must allow all actors in the system access to the same information (images, previous diagnoses, patient history, etc.) so that they can collaborate in real time and arrive at a reliable diagnosis.

To ensure that practitioners can work in good conditions, information must be available at all times and data must be sent and presented to the various actors uniformly and in sufficient quality.

4.3 Real-Time Collaborative Environments for Telemedicine

Telemedicine can be defined in the following words: it is a form of collaboration in medical practice, by connecting remotely, through information and communication technologies, a patient (and / or medical data) with one or more physicians and health professionals for the purpose of medical diagnosis, decision support and treatment in accordance with the rules of medical ethics.

Telemedicine is used in the context of patient monitoring or education and has recently been introduced in the area of emergency care. Telemedicine can be defined as the use of new telecommunication technologies in providing information [Mitra et al. 2010] and medical services to patients and doctors through audio and visual communication. These new technologies are used to help practitioners located at remote sites to perform diagnostic procedures and consultations such as clinical examinations through the transfer of medical images [Fuin et al. 2008]. These images are often large and may take time to be routed according to the networks used.

5 A New Service of Data Flow Adaptation

We propose a new service, the adaptation of data provided by information from the environment capacity manager and the exchanged data type. This web service is called WAVA and allows us to change the properties of the exchanged data within a given environment, taking into account its constraints.

5.1 WAVA: Web Service for Automatic Adaptation

The WAVA adaptation determines marks in the function of properties used by specific devices. In its turn, the adaptation server determines and reports the best quality/capacity for data to meet the requirements of the devices. Quality is determined by adaptation of the encoding type used and also the resolution and compression rate.

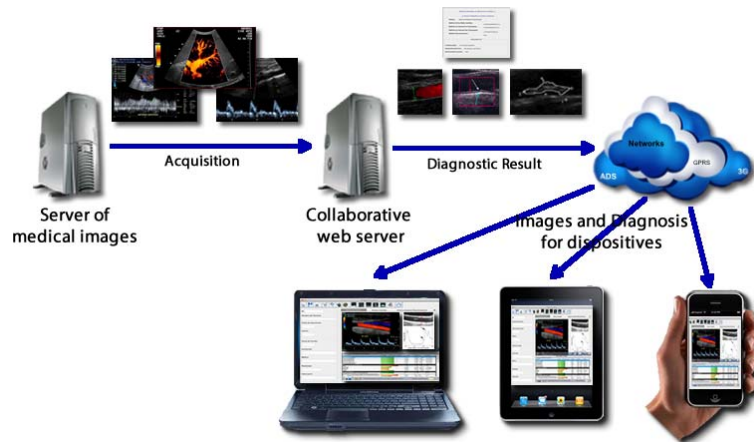

Figure 13: WAVA Principle

According to device performances (processors, graphic card, resolution) and the network used, the system provides a corresponding mark for each property. This information concerning the devices and their properties is stored in a database. A distinction must be made between two kinds of capacity evaluation. The first is the static mark that does not change during a session (Mark global (Mg)). This mark refers to CPU (Mcpu), resolution (Mres) and graphic card (Mgrph) that do not change during a session. If the devices are near each other then Mg is determined as the average of Mcpu, Mre and Mgrph, otherwise the lowest of them is used. The second kind of notation is a dynamic one. It is calculated with bandwidth (MBW) and the CPU charge (MC) that change during a session. To obtain the final mark (M), we re-evaluate the global mark with the dynamic one by taking the lower of the two marks to validate that the chosen adaptation is in concordance with the system. The use of WAVA is depicted [Fig. 13]. WAVA periodically receives information about the bandwidth and the CPU charge of the users computers/devices via information retrieved by the coordinator. The new mark is calculated in function of new information available.

5.2 WAVA Service Architecture

This prototype is also based on provided services capable of furnishing a data skeleton to applications that want to use this service. The algorithm for calculating associated marks is shown in Fig. 14. This algorithm marks the terminal that requires access to a resource from the data provided by the configuration manager. The mark ranges from zero to five, five being the highest performance. This phase is totally transparent to the user.

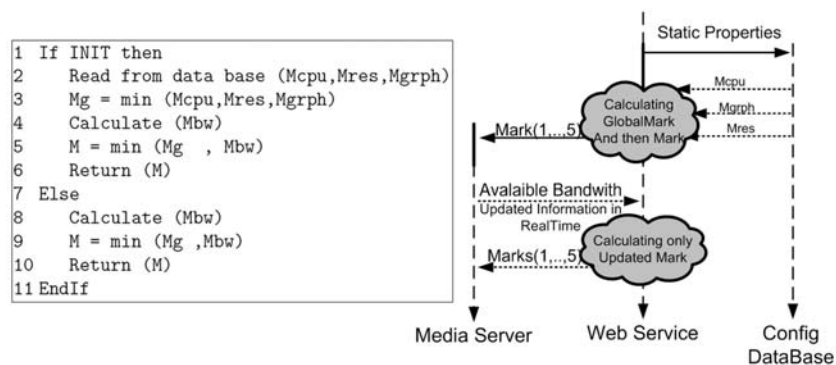

Figure 14: WAVA Algorithm

5.3 Performance

Medical research laboratories in Mexico provided 1,062 DICOM images from real patients to be used in the assessment of our automatic diagnosis system. The ROC curve obtained after the sensitivity analysis, performed to assess the diagnostic accuracy of Atherosclerosis in carotid artery ultrasound [Fig. 15(a)]. This curve was built varying the threshold from 0.1 mm to 1.3 mm with a step size of 0.01 mm; such a threshold is used by the system to emit a diagnosis. The ROC curve obtained after our tests for evaluation of the diagnostic accuracy in determining endothelial dysfunction in humeral artery ultrasound pre- and post-stimulation [Fig. 15(b)]. This curve curve was built comparing the percentage of arterial dilation with a threshold that was varied from 5% to 40% with a step size of 0.1%.

In the VACODIS teliagnosis application, the system provides physicians with three images (lumen, endothelium, and plaque measurements) and a generated synthetic text report with an automatically generated diagnosis. The WAVA platform is used for the three images but is not required for the text report. In

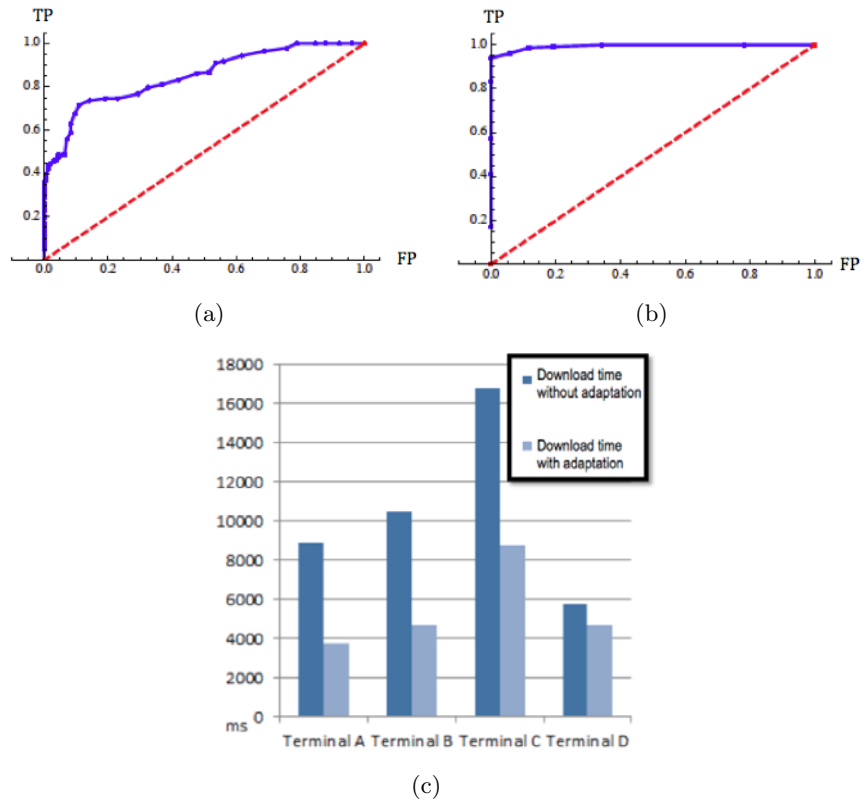

Figure 15: ROC curve (a)Atherosclerosis diagnosis, (b)Endothelium dysfunction diagnosis, (c)WAVA Performances

the following tests, we have used gray images produced by our segmentation algorithms in pixels of 1200 by 1200 with an initial size of approximately 1.5 Mo. The web service converts images to the required format depending on the previously automatically determined mark. The lowest quality corresponds to a usable format on a Smartphone without loss of quality. Users don't relate any loss of precision on images because definition of screen on smartphone is higher than on a computer screen. Test have been made in accordance with practitioners who consider the quality was sufficient to make the diagnosis.

To test the performance of this platform, different kinds of terminals have been used to connect practitioners to the platform for diagnoses. Terminal (A) an Android tablet connected to WiFi, (B) an iPad connected by HSDPA, (C) a Smartphone connected to 3G, and (D) a laptop with a WiFi connection. The results are shown in Fig. 15(c). The adapted images display faster in the termi-

nals (less CPU usage) and use less space (less memory usage). These points are of great importance for mobile terminals.

6 Conclusion

We have proposed a new tool for detection of cardiovascular abnormalities in patients. This semi-automatic tool (so-called due to its professional validation) is in use among hospital practitioners in Mexico, but it remains a local and individual tool. It is important for small hospitals (for example, regional hospitals attached to a distant University Hospital Center), to be able to guarantee the same healthcare offer regardless of the patients location. It is important for hospital experts to be able to send their opinions and participate remotely and collaboratively in the telediagnosis.

In this study we have proposed combining the semi-automatic detection tool with a collaborative adaptive platform thus allowing practitioners to share data and to co-author their remote diagnosis. The first results show that practitioners benefit from a very high level of information availability, and performance results validate this use. The phase of clinical trials is now in progress.

Until now, we have worked on two directions: (1) discrete media (images and text), but healthcare experts use echo-Doppler video recordings to visualize some blood circulation problems. Our present investigations are oriented towards the adaptability of these continuous media and any new problems that emerge, (2) the use of ontology [Hervas et al. 2010] for the traceability of telediagnosis and the representation of information.

References

- [Adams 1994] Adams Rolf. Seeded Region Growing. In *Pattern Analysis and Machine Intelligence, IEEE Transactions* Vol. 16, Issue:6, pages 641–647. Jun 1994.
- [Bishop 2000] Christopher M. Bishop. *Pattern Recognition and Machine Learning*. In *Ed. Springer Verlag, Series: Information Science and Statistics* ISBN 978-0-387-31073-2, 2000.
- [Bouix et al. 2005] Emmanuel Bouix, Philippe Roose, Marc Dalmau, and Franck Luthon. A component model for transmission and processing of synchronized multimedia data flows. In *Proceedings of the First International Conference on Distributed Frameworks for Multimedia Applications*, pages 45–53. IEEE Computer Society, 2005.
- [Brusseau et al. 2004] Brusseau, E. and de Korte, L. and Mastik, F. and Schaar, J. and van der Steen A. Fully Automatic Luminal Contour Segmentation in Intercoronary Ultrasound Imaging - A Statistical Approach. *JIEEE Trans. Med. Imag.*, Vol. 23(1)., 2004.
- [Campbell et al.1997] Campbell, N. W. and Thomas and B. T. and Troscianko, T. A Two-Stage Process for Accurate Image Segmentation. *Proc. Sixth International Conference on Image Processing and its Applications*. IEEE., 1997.
- [Chang 2004] Chang Chun-Ling and Zhang Yun-Jie and Gdong, Yun-Yin. Cellular Automata for Edge Detection of Images. *JIEEE Proceedings of the Third International Conference on Machine Learning and Cybernetic*, 2004.

- [Dalmau et al. 2009] Marc Dalmau, Philippe Roose, and Sophie Laplace. Context aware adaptable applications - a global approach. In *International Journal of Computer Science - IJCSI*, volume 1, pages 13–25, 2009.
- [Davignon et al. 2004] Davignon Jean and Ganz Peter. Role of Endothelial Dysfunction in Atherosclerosis. American Heart Association, Inc., pages 27–32, 2004.
- [Duque et al. 2009] Rafael Duque, Crescencio Bravo, and Manuel Ortega. A conceptual model for analysing collaborative work and products in groupware systems. In *Proceedings of the 6th international conference on Cooperative design, visualization, and engineering*, CDVE'09, pages 125–132, Berlin, 2009. Springer-Verlag.
- [Elmarzouqi et al. 2007] Nabil Elmarzouqi, Eric Garcia, Jean-Christophe Lapayre, and P. Humbert. Use of ACCM model for teledermatology implementation. In *DFMA'07, 3rd int. workshop on Distributed Framework for Multimedia Applications*, pages 84–89, Paris, France, July 2007.
- [Elmarzouqi et al. 2008] Nabil Elmarzouqi, Eric Garcia, and Jean-Christophe Lapayre. CSCW from coordination to collaboration. In *Revised Selected Papers from CSCWD'07, Computer Supported Cooperative Work in Design IV*, volume 5236 of *LNCIS Book*, pages 87–98. Springer, 2008.
- [Fuin et al. 2008] David Fuin, Eric Garcia, Hervé Guyennet, and Jean-Christophe Lapayre. Collaborative interactions for medical e-Diagnosis. In *HPCN, Int. Journal on High-Performance Computing and Networking*, volume 5, pages 189–197, 2008.
- [Garcia et al. 2004] Eric Garcia, Julien Henriet, and Jean-Christophe Lapayre. Gestion du multimédia sur une plate-forme générique basée sur les web-services. In *procs. of the IEEE Int. Conf. SETIT'2004*, pages 104–112, Sousse, Tunisia, March 2004. ISBN: 9973-41-902-2.
- [Hervas et al. 2010] Ramon Hervas and Jose Bravo and Jesus Fontecha. A Context Model based on Ontological Languages: a Proposal for Information Visualization. In *Journal of Universal Computer Science*, Vol.16(12), pages 1539–1555, June 2010.
- [Hunter et al. 1979] Hunter, M. and Steiglitz, K. Operations on Images Using Quadtree. *IEEE Transactions on Pattern Analysis and Machine Intelligence*, 1979.
- [Loizou et al. 2005] Loizou, CP and Pattichis, CS and Christodoulou, CI and Istepanian, RS and Pantziaris, M and Nicolaides, A. comparative evaluation of despeckle filtering in ultrasound imaging of the carotid artery. *IEEE Trans. On Ultrasonics, Ferroelectrics, and Frequency Control*, Vol. 52, 2005.
- [Louberry et al. 2009] Christine Louberry, Philippe Roose, and Marc Dalmau. Qos-based design process for pervasive computing applications. In *Proceedings of the 6th International Conference on Mobile Technology Application Systems Mobility*, pages 1–4, New York, 2009. ACM.
- [Mitra et al. 2010] Mitra, J. and Jolivot, R. and Vabres, P and Marzani F.S. Source separation on hyperspectral cube applied to dermatology. In *SPIE Medical Imaging meeting, Computer-Aided Diagnosis*, Vol. 7624, pages 1–11, San Diego, California, USA, 13-18 february 2010.
- [Mrak et al. 2009] Marta Mrak, Janko alić, and Ahmet Kondoz. Fast analysis of scalable video for adaptive browsing interfaces. In *Computer Vision and Image Understanding*, volume 113, pages 425–434, New York, NY, USA, 2009. Elsevier Science Inc.
- [Pham et al. 2007] Pham, Mailan and Susomboon, Ruchaneewan and Disney, Tim and Raicu, Daniela and Furst, Jacob. A Comparison of Texture Models for Automatic Liver Segmentation. *SPIE In Medical Imaging*, 2007.
- [Pianikh 2011] Pianikh, Oleg S. Digital Imaging and Communications in Medicine (DICOM): A Practical Introduction and Survival Guid. JSpringer, ISBN 3642108490, 2011.
- [Rivera et al. 2002] Rivera, M. and Marroquin, J. L. Adaptive Rest Condition Potentials: First and Second Order Edge-Preserving Regularization. 2002.
- [Rubin et al. 2000] Rubin, Y. N. and Garcia, S. and Thomas W.J. Qualitative and Quantitative Effects of Harmonic Echocardiographic Imaging on Endo-cardial Edge

- Definition and Side-Lobe Artifact. *Journal of the American Society of Echocardiography*, 2000.
- [Selvaraj et al. 2007] Nallini Selvaraj, Bob Fields, and Paola Amaldi-Trillo. Decisions and collaborative work: a different perspective. In *Proceedings of the 14th European conference on Cognitive ergonomics*, ECCE '07, pages 243–246, New York, 2007. ACM.
- [Severo et al. 2012] Severo C.B., Ribeiro J.P., Umpierre D., Da Silveira A.D., De Aquino Neto F.R., and Stein R. Increased Atherothrombotic Markers and Endothelial Dysfunction in Steroid Users. *European Journal of Preventive Cardiology*, pages 195–201, February 2012.
- [Sun et al. 2002] Chengzheng Sun and David Chen. Consistency maintenance in real-time collaborative graphics editing systems. volume 9, pages 1–41, New York, NY, USA, 2002. ACM.
- [Theodoridis et al. 2005] Theodoridis, Sergios and Koutroumbas, Konstantinos. *Pattern Recognition*. ISBN: 9780080949123, Elsevier Academic Press 2005.
- [Watkins 2010] Ryan Watkins. e-learning - tool for training and professional development services, e-learning, development of knowledge and/or skills for building competence. In *Handbook of Improving Performance in the Workplace: Selecting and Implementing Performance Interventions*, pages 577–597. John Wiley and Sons, Inc., 2010.
- [Ziegler et al. 2010] Jürgen Ziegler, Jörg M. Haake, Stephan Lukosch, and Volkmar Pipek. Context-adaptive interaction for collaborative work. In *Proceedings of the 28th of the international conference extended abstracts on Human factors in computing systems*, CHI EA '10, pages 4461–4464, New York, 2010. ACM.